

Digital Imaging System

Operating Instructions (For PostScript)

DA-MC700

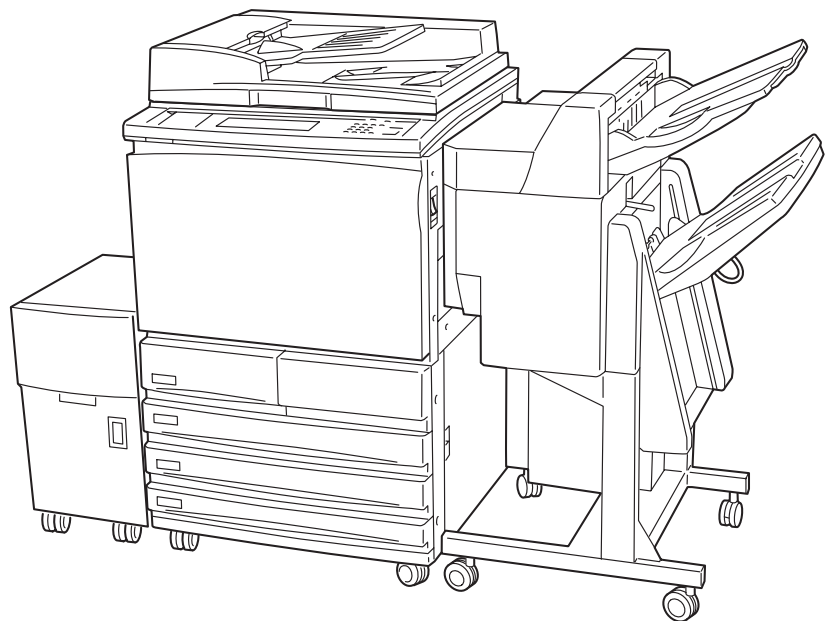

Before operating this machine, please read these instructions completely and keep these operating instructions for future reference.

English

TRADEMARKS/COPYRIGHTS

The following trademarks and registered trademarks are used throughout this manual.

Microsoft, MS-DOS, Windows, and Windows NT are either registered trademarks or trademarks of Microsoft Corporation in the United States and/or other countries.

i386, i486, and Pentium are either registered trademarks or trademarks of Intel Corporation.

Adobe, the Adobe logo, Adobe PostScript, Acrobat, Acrobat Reader, and Acrobat logo are either registered trademarks or trademarks of Adobe Systems Incorporated in the United States and/or other countries.

Apple, the Apple logo, LaserWriter, Mac, Mac logo, Macintosh, Power Macintosh, and TrueType are either registered trademarks or trademarks of Apple Computer, Inc. in the United States and/or other countries.

Novell, Novell Client, Novell Directory Services, Novell Distributed Print Services, Netware, intraNetware, NDPS, NDS, , IPX, IPX/SPX, NDS Admin, NDS Administrator are either registered trademarks or trademarks of Novell, Inc., in the United States and/or other countries.

Panasonic Document Imaging Company has made every effort to supply trademark information about company names, products and services mentioned in this documentation. All third party and/or other trademarks identified herein are the property of their respective owners.

Copyright © 2001 by Matsushita Graphic Communication Systems, Inc.
All rights reserved.

Copyright protection claimed includes all forms and matters of copyrightable material and information now allowed by statutory or judicial law or hereinafter granted, including without limitation, material generated from the software programs that are displayed on the screen such as styles, templates, icons, screen displays, looks, etc.

Contents are subject to change without notice.

Printed in Japan.

Preface

Thank you for purchasing the PostScript Driver Library.

These Operating Instructions contain information on the various types of software included in the PostScript Printer Driver & Documentation CD-ROM as well as on how to install and use them. Please read this manual first before you begin to use the software to ensure smooth operation.

This manual is written with the assumption that you are familiar with the basics of the Microsoft Windows Operating System and Macintosh, and that you have understood the operation of the printer with the aid of the Operating Instructions (For Printer). You may also refer to their respective user manuals regarding the basic knowledge and operation method of the product. Note that this manual is written for users operating the DP-6000/7000* with a client computer installed with an English edition operating system only.

After reading, keep these operating instructions handy for a quick reference should you encounter any difficulties when using the machine.

* DP-6000 USA/Canada only.

PostScript Driver Library

The following types of software are included in the PostScript Printer Driver & Documentation CD-ROM.

Types of Software Included

LOOK  The “Readme.txt” files contain important information. Be sure to read them.

Printer Driver (for Windows 95/98/Me)

Adobe PostScript driver (AdobePS 4.4) for Windows 95/98/Me, including a PPD file to add Panasonic printer information to the driver. Refer to section “1.2 Installing the Printer Driver (AdobePS 4.4)” to install the printer driver.

Printer Driver (for Windows NT 4.0)

Adobe PostScript driver (AdobePS 5.1) for Windows NT 4.0, including a PPD file to add Panasonic printer information to the driver. Refer to section “2.2 Installing the Printer Driver (AdobePS 5.1)” to install the printer driver.

Printer Driver (for Windows 2000)

Microsoft PostScript driver (MS PScript 5) for Windows 2000, including a PPD file to add Panasonic printer information to the driver. Refer to section “3.2 Installing the Printer Driver (Microsoft PScript 5)” to install the printer driver.

ATM (for Windows 95/98/Me and Windows NT 4.0)

Adobe Type Manager for Windows 95/98/Me and Windows NT 4.0.

Adobe Screen Fonts (for Windows 95/98/Me and Windows NT 4.0)

Includes 136 typefaces of screen fonts which are standard for Adobe PostScript 3. There are 19 TrueType fonts and 117 PostScript fonts. To install these fonts, open the Fonts folder in Control Panel and from the “File” menu, choose the appropriate command.

Acrobat Reader (for Windows 95/98/Me, Windows NT 4.0 and Windows 2000)

Adobe Acrobat Reader for Windows 95/98/Me, Windows NT 4.0 and Windows 2000 to view and print PDF (Portable Document Format) files.

Printer Driver (for Macintosh)

Adobe PostScript driver (AdobePS 8.5/8.7) for Macintosh. Refer to section “4.3 Installing the Printer Driver (AdobePS 8.5/8.7)” for the details.

PS Utility (for Macintosh)

This is used to specify printer settings from Macintosh. Refer to section “4.6 Panasonic PS Utility” for the details.

ATM (for Macintosh)

Adobe Type Manager for Macintosh.

Adobe Screen Fonts (for Macintosh)

Includes 136 typefaces of screen fonts which are standard for Adobe PostScript 3. There are 19 TrueType fonts and 117 PostScript fonts. In addition, 37 PostScript fonts of the Central European (CE) character set are included. Refer to section “4.5 Installing the Adobe Screen Fonts” to install the fonts.

Acrobat Reader (for Macintosh)

Adobe Acrobat Reader for Macintosh to view and print PDF files.

Contents

◆ Preface	i
◆ PostScript Driver Library	ii
◆ Contents	iv
◆ About the Attached CD-ROM	vi
◆ Using These Operating Instructions	vii

Chapter 1 Installing the Printer Driver for Windows 95/98/Me

1.1 About the Software	2
1.1.1 Bundled Software	2
1.1.2 Hardware/Software Requirements	2
1.2 Installing the Printer Driver (AdobePS 4.4)	3
1.2.1 Method of Installation	3
1.2.2 Optional Settings	7
1.2.3 Features List	8
1.3 Using Help	11

Chapter 2 Installing the Printer Driver for Windows NT 4.0

2.1 About the Software	14
2.1.1 Bundled Software	14
2.1.2 Hardware/Software Requirements	14
2.2 Installing the Printer Driver (AdobePS 5.1)	15
2.2.1 Method of Installation	15
2.2.2 Optional Settings	20
2.2.3 Printer Features	21
2.3 Using Help	23

Chapter 3 Installing the Printer Driver for Windows 2000

3.1 About the Software	26
3.1.1 Bundled Software	26
3.1.2 Hardware/Software Requirements	26
3.2 Installing the Printer Driver (Microsoft PScript 5)	27
3.2.1 Method of Installation	27
3.2.2 Optional Settings	32
3.2.3 Printer Features	33
3.3 Using Help	36

Chapter 4 Installing the Printer Driver for Macintosh

4.1	Configuring the Printer	38
4.1.1	Enabling Port and Setting Protocol	38
4.1.2	Other Settings	40
4.2	About the Software	41
4.2.1	Bundled Software	41
4.2.2	Hardware/Software Requirements	41
4.3	Installing the Printer Driver (AdobePS 8.5/8.7).....	42
4.3.1	Installing the Printer Driver	42
4.3.2	Configuring the Printer Driver	44
4.4	Printer Features	47
4.4.1	Printer Specific Options.....	47
4.5	Installing the Adobe Screen Fonts.....	49

Appendix

A	Cautions/Limitations.....	52
	Index	54

About the Attached CD-ROM

The following are files included in CD-ROM “PostScript Printer Driver & Documentation”.

About the attached CD-ROM

CD-ROM for the PS3 (PostScript 3) kit: “PostScript Printer Driver & Documentation (Macintosh/Windows)”

- AdobePS (Adobe PS printer drivers and PPD files)
(for Windows 95/98/Me, Windows NT 4.0, Windows 2000, Macintosh)
- ATM (Adobe Type Manager)
(for Windows 95/98/Me, Windows NT 4.0, Macintosh)
- SFONT (Adobe PS 3 Screen Font) (TrueType/Type 1)
(for Windows 95/98/Me, Windows NT 4.0, Macintosh)
- ACROBAT (Adobe Acrobat Reader)
(for Windows 95/98/Me, Windows NT 4.0, Windows 2000, Macintosh)
- Manual (in PDF format):
PostScript.pdf: “Operating Instructions (For PostScript)”
- Readme.txt

Manuals Bundled With DP-6000/7000

Several manuals are bundled with DP-6000/7000 machine, including Operating Instructions (For Copier), Operating Instructions (For Printer), and Operating Instructions (For Scanner). These manuals explain how to set up, manage, and use the machine.

Using These Operating Instructions

Organization of This Manual

The following is a brief summary of each chapter.

Chapter 1 Installing the Printer Driver for Windows 95/98/Me

This chapter explains the procedure of installing the Adobe printer driver on Microsoft Windows 95/98/Me operating systems, the necessary settings and the items that can be set during printing.

Chapter 2 Installing the Printer Driver for Windows NT 4.0

This chapter explains the procedure of installing the Adobe printer driver on Microsoft Windows NT Workstation operating system version 4.0 and Microsoft Windows NT Server network operating system version 4.0, the necessary settings and the items that can be set during printing.

Chapter 3 Installing the Printer Driver for Windows 2000

This chapter explains the procedure of installing the Microsoft Windows 2000 printer driver on Microsoft Windows 2000 operating system and Microsoft Windows 2000 Server network operating system, the necessary settings and the items that can be set during printing.

Chapter 4 Installing the Printer Driver for Macintosh

This chapter explains how to install the printer driver, fonts and utility on the Macintosh, and at the same time, how to utilize them.

Appendix

This section explains how to download the latest version of the software from the internet, the points which you have to take note, and the limitations of the printer.

Conventions

- ① The following icons are used in this manual.



Indicates important information and must be read in detail.



Indicates supplementary information.



Indicates references used in this manual. Manual titles are noted without double quotes while specific sections like “4.2.2 Hardware/Software Requirements” are found within double quotes.

- ② The following conventions are used in this manual.

“ ”

: Double quotes are used to indicate names of files, windows, dialog boxes and input contents.
E.g. The “Run” dialog box appears.

Bold face

: Boldface characters refer to window menu items, dialog box items and all kinds of buttons.
E.g. Click **OK**.

- ③ When a checkbox is checked, it indicates ON, otherwise it indicates OFF.

E.g. “Image Enhancement” is on.



“Image Enhancement” is off.



- ④ The item with the radio button checked is the selected item.

E.g. “Millimetre” is selected.





1

Installing the Printer Driver for Windows 95/98/Me

1.1	About the Software	2
1.2	Installing the Printer Driver (AdobePS 4.4)	3
1.3	Using Help	11



About the Software

This section explains the types of software provided and the hardware/software required to use with the printer when operating on Windows 95, Windows 98 or Windows Me.

1.1.1 Bundled Software

The following items are included in the “Driver PS3\Win9x_Me” folder and “Utilities\Win9x_Me” folder on the enclosed CD-ROM.

- **AdobePS Printer Driver (ver. 4.4x) and PPD files**
Adobe PostScript driver and PPD files (for Windows 95/98/Me).
- **ATM (Adobe Type Manager) (ver. 4.0)**
Helps you to install typefaces, activate and manage your fonts.
- **Adobe Screen Fonts (TrueType/PostScript)**
Includes 136 screen font typefaces (19 TrueType fonts and 117 PostScript fonts) which are compatible with the printer fonts. ATM is used to install the PostScript screen fonts. When using these fonts to print, you are recommended to use the Adobe PostScript (4.4x) printer driver.
- **Acrobat Reader**
Enables you to view and print PDF files on all major computing platforms.
- **Readme.txt**
Contains the cautionary notes on using the printer driver. Be sure to read this.

1.1.2 Hardware/Software Requirements

The operating environment for the Windows 95/98/Me printer driver is as follows:

Computer System

- i386, i486, or Pentium processor-based personal computer (i486 or Pentium processor recommended)
- 8 MBytes of available RAM (16 MBytes recommended)
- 6 MBytes of available hard-disk space (8 MBytes required for full driver installation)

Basic Software

- Windows 95, Windows 98 or Windows Me



Installing the Printer Driver (AdobePS 4.4)

The Adobe printer driver (AdobePS 4.4) can be installed by simply following the instructions displayed on the dialog boxes. Get ready the enclosed CD-ROM and follow the procedure below. The following installation procedure is performed in Windows 95.



- Click the **Help** button for details on the settings and the way of operation.
- Click the **Cancel** button in the dialog box to end the installation and the **Back** button to cancel the setting at that stage and return to the previous dialog box.

1.2.1 Method of Installation

Procedure

- 1 Switch on the printer.
- 2 Switch on the computer and start Windows 95.
- 3 Click the “Start” menu and select **Settings**, then **Printers**.
The “Printers” window appears.
 You can also double-click the **Printers** icon on “My Computer” window.
- 4 Double-click the “Add Printer” icon on the “Printers” window.
- 5 Follow the instructions and click **Next**.
- 6 If the printer is to be connected directly to the computer, select **Local printer**. Otherwise, select **Network printer**.
Here, we select **Local printer** as an example.

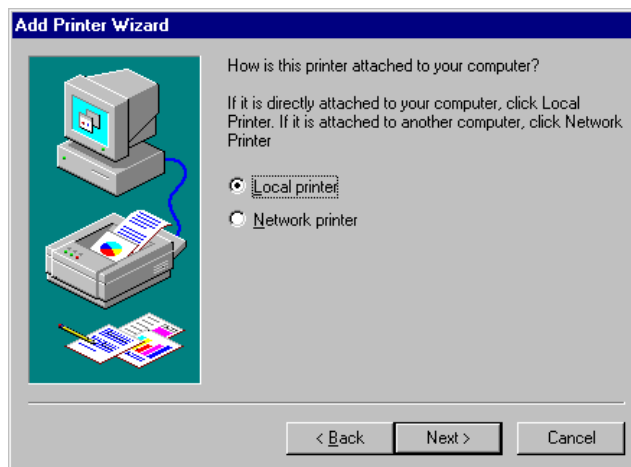

1.2 Installing the Printer Driver (AdobePS 4.4)

7 Click **Next**.



*If **Network printer** is selected, enter the Network path or queue name and then click **Next**. You can also click the **Browse** button and search the network for the printer.*

8 Click **Have Disk**.



Steps 8 to 12 are not necessary depending on the network environment settings you are using.

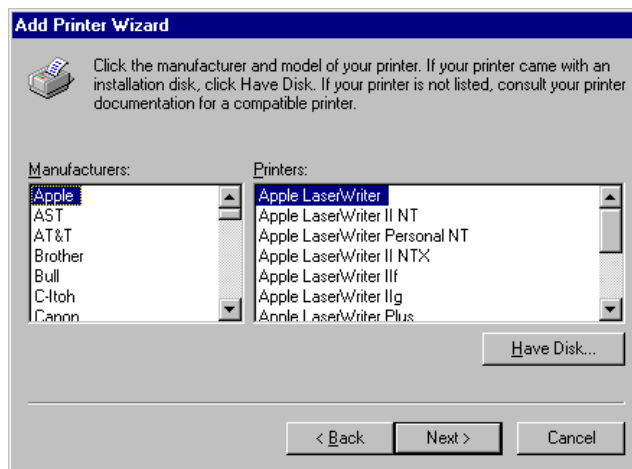

The “Install From Disk” dialog box is displayed.

9 Insert the CD-ROM, enter “F:\Driver_PS3\Win9x_Me” and click **OK**.



In this manual, “F:” is used as a CD-ROM drive, but if you are using a different drive for the CD-ROM, please specify accordingly.



The “Add Printer Wizard” dialog box is displayed.

- 10 From the printers available, select **Panasonic DP-6000/7000 PS** and click **Next**.

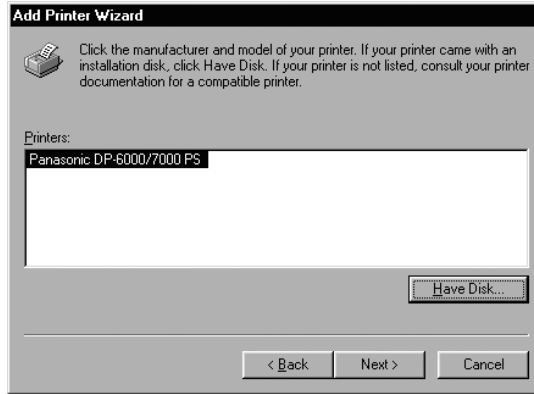

- 11 Select the port to be used and click **Next**.

Note 

Refer to the printer/scanner kit or the manuals bundled with the printer that contain information about the printer features for the details of configuring the port.



- 12 Input the printer name. Choose whether you want to use the printer as the default printer, then click **Next**.

To change the printer name, enter a name of your choice in the text box. Otherwise the printer name displayed in the text box will be used.

Select **Yes** if you want to use the printer as the default printer.

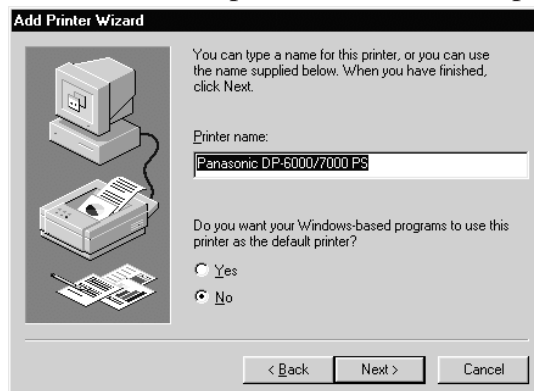

1.2 Installing the Printer Driver (AdobePS 4.4)

- 13 After the printer is installed, specify whether to print the test page by clicking **Yes** or **No**. Then click **Finish**. If you have selected **Yes** to print test page, a test page will be printed after the installation is finished.

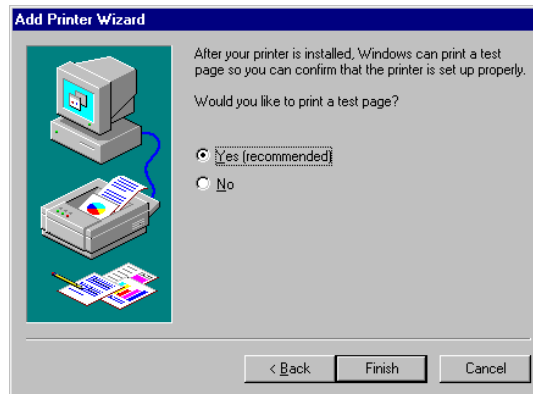

The “End User License Agreement” dialog box is displayed.

- 14 Click **Accept**.



The file is copied and installation of the printer driver is completed. Take out the CD-ROM. If you have selected to test print, a dialog box is displayed. Click **Yes** if the test print is printed correctly. If it is not, click **No** and follow the instructions on the dialog box.

- LOOK**  • Select the **Decline** button and a dialog box “The installation is incomplete. If you exit now, the driver may not be installed correctly. Do you want to exit now?” is displayed.
- Store the CD-ROM properly.

1.2.2 Optional Settings

To configure optional settings installed on the printer, select the “Options” tab on the “Printer Properties” dialog box. The following shows how to display the “Options” tab.

Procedure

- ❶ Click on the printer icon on the “Printers” window.
- ❷ From the “File” menu, click **Properties**.
- ❸ Click the “Options” tab.

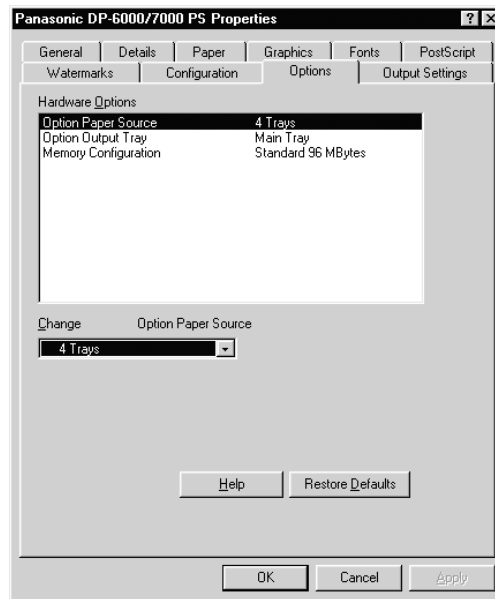

●●● Hardware Options

Option Paper Source

Specify the type of option sheet feeder installed. The options available are **3 Trays + Multi-Tray***, **4 Trays** (default), **3 Trays (HCF) + Multi-Tray*** and **4 Trays (HCF)**. If the High Capacity Feeder (HCF) is installed on your printer, select **4 Trays (HCF)**.

* Multi-Tray is not available in the DP-6000/7000.

Option Output Tray

Specify the type of option output tray installed on your printer. The options available are **Main Tray** (default) and **Finisher**.

Memory Configuration

The standard memory for this machine is 96 MBytes and this setting cannot be changed.

1.2.3 Features List

To do settings for the features list, click the “Configuration” tab on the “Printer Properties” dialog box.

Procedure

- 1 Click on the printer icon on the “Printers” window.
- 2 From the “File” menu, click **Properties**.
- 3 Click the “Configuration” tab.

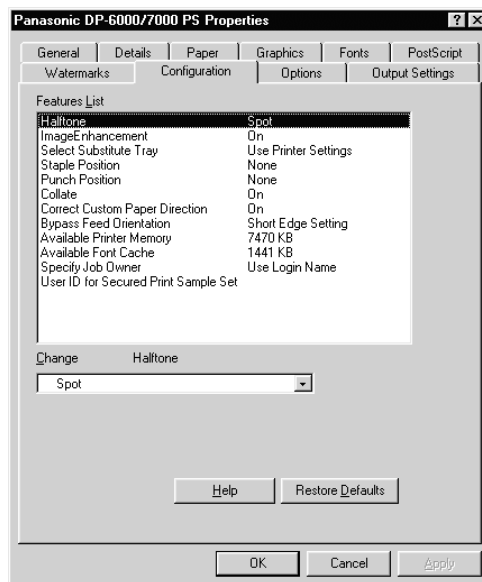

Features List

Halftone

Select here the type of toning pattern you want. The settings that are selectable in the application may become invalid.

Image Enhancement

Reduce the slipping and jaggging of the black and white boundary and increase the pseudo resolution.

Select Substitute Tray

The following selections are available:

- Use Printer Settings
- Nearest size (Adjust to Fit)
- Nearest size (No Zoom)
- Next larger size (Adjust to Fit)
- Next larger size (No Zoom)
- Abort Job

Staple Position

Specify whether you want the documents to be stapled and where you want them stapled.

Punch Position

Specify whether you want the documents to be punched and where you want them punched.

Collate

Specify whether you want the documents to be collated or not.

Correct Custom Paper Direction

When you are using a non-standard paper size, select the paper direction. Depending on the application, printing may be done incorrectly on the non-standard sized paper. Select **On** to avoid this.

Bypass Feed Orientation

Specify **Short Edge Setting** or **Long Edge Setting**.

Available Printer Memory

Specify the memory in KB that can be used as the printer memory. Enter an integer between 0 and 200000.

Available Font Cache

Specify the font cache in KB that can be used. Enter an integer between 0 and 25600.

Specify Job Owner

The following selections are available:

Use Login Name

Use the Windows Logon Name as a job owner name. The job owner name will become the “Logon User Name\Host Name”. Up to 31 characters can be used for the logon name. If it exceeds 31 characters, only the first 31 characters will be used.

Input Owner Name

Select this if you wish to specify a custom job owner name. Enter any job owner name in the “Job Owner Name” edit box. Up to 31 characters can be entered for the job owner name. If it exceeds 31 characters, only the first 31 characters will be used. Its default value is “Unknown User”.

User ID for Secured Print Sample Set

Specify the user ID for Secured Print or Sample Set with a maximum of 24 alphanumeric characters. If the user ID is previously specified, it will be displayed in the edit box. If you are using Secured Print, you will also be prompted to enter the password. You can enter up to four digits and each input digit is represented by an asterisk.





1.3 Using Help

Follow the procedure below to use Help and to define the settings.

Procedure

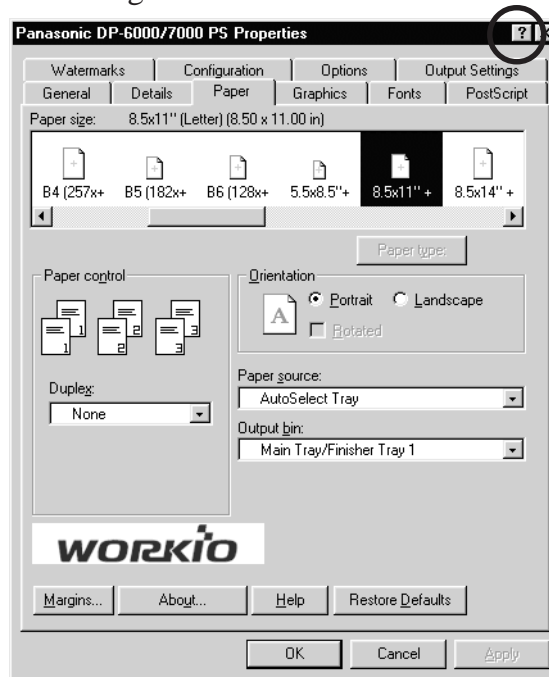
- 1 The  button is located at the top right corner of the “Print” or “Properties” dialog box.



- 2 Click . A “?” mark appears next to the mouse pointer. Move the mouse pointer with the “?” mark to the item which you wish to know more about and click on it. This will display a pop-up message with information about that item.

The pop-up message disappears when you click again anywhere on the screen. You can also click directly on the displayed Help button for information about the selected tab.

This page is intentionally left blank.

A stylized white line-art illustration on a grey background. It depicts a person sitting at a desk with a computer monitor and keyboard. The person's head is represented by a circle with a large white number '2' inside. The desk, keyboard, and monitor are drawn with simple, thick white lines. There are also some decorative elements like small circles and wavy lines.

2

Installing the Printer Driver for Windows NT 4.0

2.1	About the Software	14
2.2	Installing the Printer Driver (AdobePS 5.1)	15
2.3	Using Help	23



About the Software

This section explains the types of software provided and the hardware/software required to use with the printer when operating on Windows® NT 4.0.

2.1.1 Bundled Software

The following items are included in the “Driver_PS3\NT40” folder and “Utilities\NT40” folder on the enclosed CD-ROM.

- **AdobePS printer driver (ver. 5.1) and PPD files**
Adobe PostScript driver and PPD files (for Windows NT 4.0).
- **ATM (Adobe Type Manager) (ver. 4.0)**
Helps you to install typefaces, activate and manage your fonts.
- **Adobe Screen Fonts (TrueType/PostScript)**
Includes 136 screen font typefaces (19 TrueType fonts and 117 PostScript fonts) which are compatible with the printer fonts. ATM is used to install the PostScript screen fonts. When using these fonts to print, you are recommended to use the Adobe PostScript (5.1) printer driver.
- **Acrobat Reader**
Enables you to view and print PDF files on all major computing platforms.
- **Readme.txt**
Contains the cautionary notes on using the printer driver. Be sure to read this.

2.1.2 Hardware/Software Requirements

The operating environment for the Windows NT 4.0 printer driver is as follows:

Computer System

- i486 or Pentium processor-based personal computer (i486 or Pentium processor recommended)
- 16 MBytes of available RAM (32 MBytes recommended)
- 6 MBytes of available hard-disk space

Basic Software

- Windows NT Workstation 4.0/Windows NT Server 4.0 (Service Pack 5 or above)



Installing the Printer Driver (AdobePS 5.1)

The Adobe printer driver (AdobePS 5.1) can be installed by simply following the instructions displayed on the dialog boxes. Get ready the enclosed CD-ROM and follow the procedure below.

- Note** 
- Click the *Help* button for details on the settings and the method of operation.
 - Click the *Cancel* button in the dialog box to end the installation and the *Back* button to cancel the setting at that stage and return to the previous dialog box.

2.2.1 Method of Installation

Procedure

- 1 Start Windows NT 4.0. Click the “Start” menu, select **Printers** from “Settings” and then double-click the “Add Printer” icon.
Note  Logon as a member of the “Power User” group or as the “Administrator”. Refer to the user guide for Windows NT 4.0 for information on the “Power User” group.
- 2 Indicate how the printer is connected to your computer. Then click **Next**. If the printer is directly connected to your computer, select **My Computer**. Otherwise, select **Network printer server**.



The “Add Printer Wizard” dialog box changes display.

2.2 Installing the Printer Driver (AdobePS 5.1)

- ③ Select the port in **Available ports** and click **Next**.

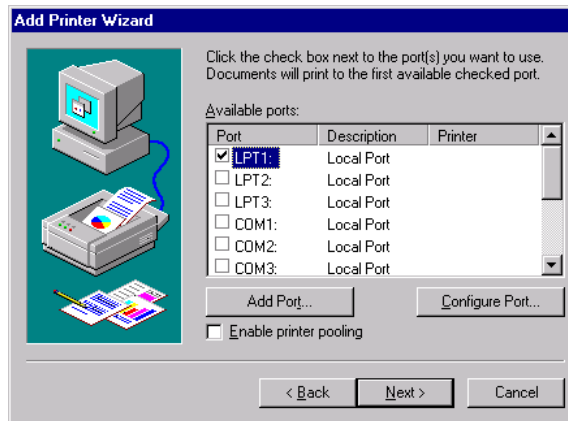

The “Add Printer Wizard” dialog box is displayed.

- ④ Click **Have Disk**.

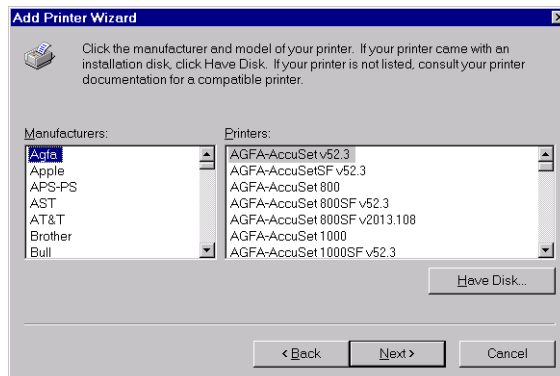

The “Install From Disk” dialog box is displayed.

- 5 Insert the CD-ROM, enter “F:\Driver_PS3\NT40” and click **OK**.



In this manual, “F:” is used as a CD-ROM drive, but if you are using a different drive for the CD-ROM, please specify accordingly.

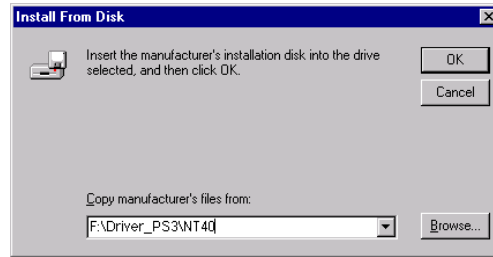

- 6 From the printers available, select **DP-6000/7000 PS** and click **Next**.

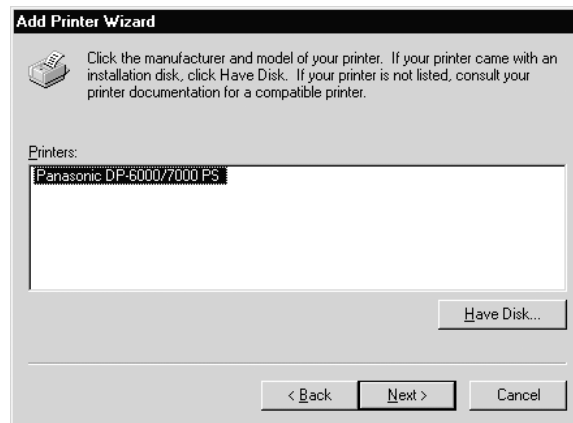

2.2 Installing the Printer Driver (AdobePS 5.1)

- 7 Input the printer name. Choose whether you want to use the printer as the default printer, then click **Next**.

To change the printer name, enter a name of your choice in the text box. Otherwise the printer name displayed in the text box will be used.

Select **Yes** if you want to use the printer as the default printer.



- 8 Choose whether you want to share this printer with the other network users. Click **Next**.

If you choose **Shared**, input a name for the printer in the “Share Name” text box and then select the operating system of all computers that will be printing to this printer.



- 9 After the printer is installed, specify whether to print the test page by clicking **Yes** or **No**. Then click **Finish**. If you have selected **Yes** to print test page, a test page will be printed after the installation is finished.



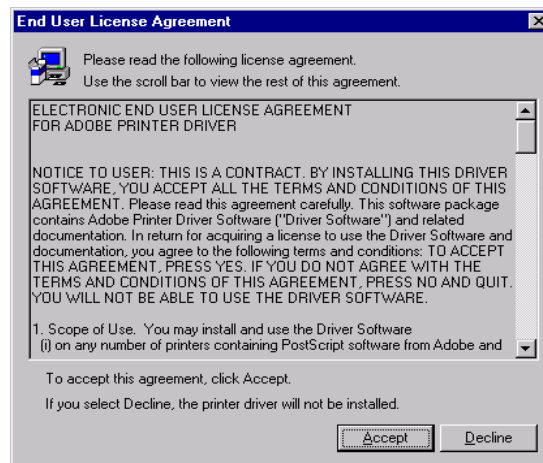

The “End User License Agreement” dialog box is displayed.

- 10 Click **Accept**.



The file is copied and installation of the printer driver is completed. Take out the CD-ROM. If you have selected to test print, a dialog box is displayed. Click **Yes** if the test print is printed correctly. If it is not, click **No** and follow the instructions on the dialog box.

Note  It is necessary to change the settings on the “Device Settings” tab in order to use the printer’s optional features. Refer to the next section and make sure you change the settings.

- LOOK**  • Select the **Decline** button and a dialog box “The installation is incomplete. If you exit now, the driver may not be installed correctly. Do you want to exit now?” is displayed.
- Store the CD-ROM properly.

2.2.2 Optional Settings

To configure optional settings installed on the printer, select the “Device Settings” tab on the “Printer Properties” dialog box. The following shows how to display the “Device Settings” tab.

Procedure

- 1 Click on the printer icon on the “Printers” window.
- 2 From the “File” menu, click **Properties**.
- 3 Click the “Device Settings” tab.

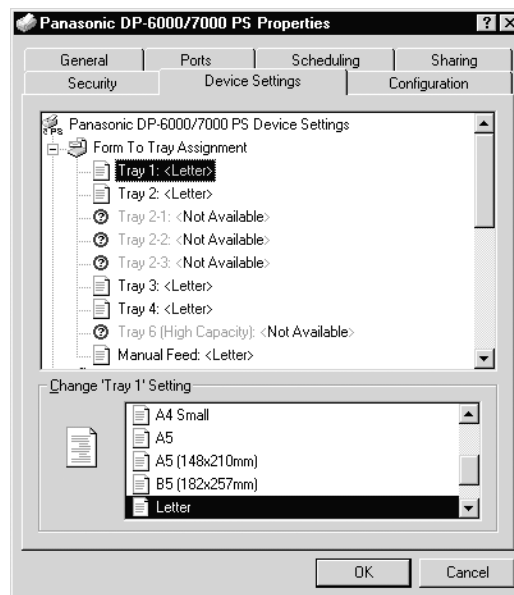

●●● Install able Options

Memory Configuration

The standard memory for this machine is 96 MBytes and this setting cannot be changed.

Option Paper Source

Specify the type of optional sheet feeder installed on your printer.

Option Output Tray

Specify the type of option output tray installed on your printer.

2.2.3 Printer Features

To do settings for the features list, select the “Advanced” tab on the “Printer Properties” dialog box.

Procedure

- ❶ Click on the printer icon on the “Printers” window.
- ❷ From the “File” menu, click **Document Defaults**.
- ❸ Click the “Advanced” tab.
- ❹ Click **Document Options**.

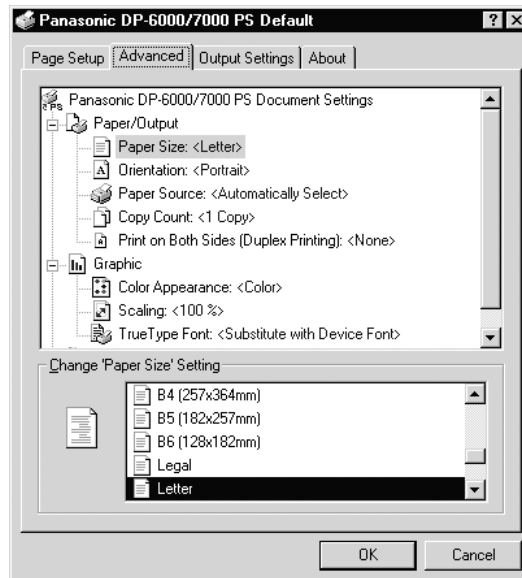

●●● Printer Features

Halftone

Select here the type of toning pattern you want. The settings that are selectable in the application may become invalid.

Image Enhancement

Reduce the slipping and jaggging of the black and white boundary and increase the pseudo resolution.

Output Destination

Specify the type of output tray installed on your printer. The options available are **Main Tray/Finisher Tray 1** and **Finisher Tray 2**.

Staple Position

Specify whether you want the documents to be stapled and where you want them stapled.

Punch Position

Specify whether you want the documents to be punched and where you want them punched.

Bypass Feed Orientation

Specify **Short Edge Setting** or **Long Edge Setting**.

Select Substitute Tray

The following selections are available:

- Use Printer Settings
- Nearest size (Adjust to Fit)
- Nearest size (No Zoom)
- Next larger size (Adjust to Fit)
- Next larger size (No Zoom)
- Abort Job

Correct Custom Paper Direction

When you are using a non-standard paper size, select the paper direction. Depending on the application, printing may be done incorrectly on the non-standard sized paper. Select **On** to avoid this.





2.3 Using Help

Follow the procedure below to use Help and to define the settings.

Procedure

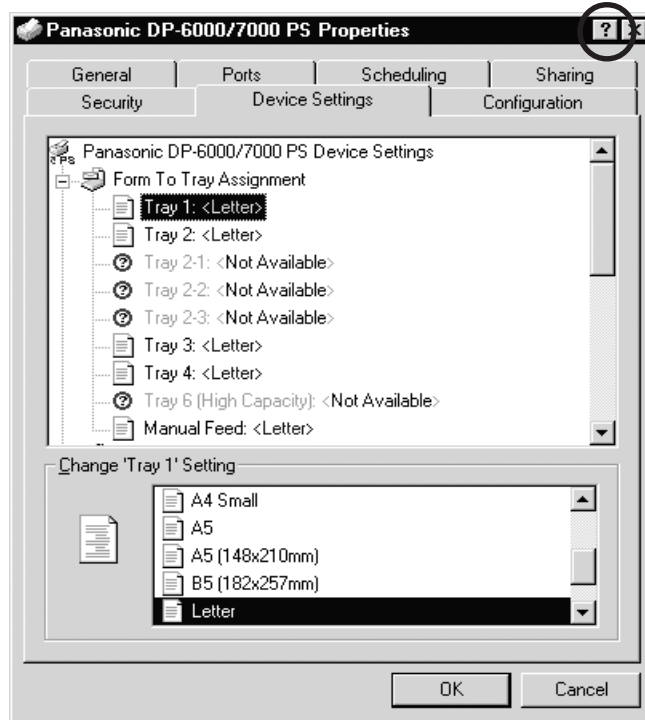
- 1 The  button is located at the top right corner of the dialog box.



- 2 Click . A “?” mark appears next to the mouse pointer. Move the mouse pointer with the “?” mark to the item which you wish to know more about and click on it. This will display a pop-up message with information about that item.

The pop-up message disappears when you click again anywhere on the screen.

This page is intentionally left blank.



Installing the Printer Driver for Windows 2000

3.1	About the Software	26
3.2	Installing the Printer Driver (Microsoft PScript 5).....	27
3.3	Using Help	36



About the Software

This section describes the software provided and the hardware/software required to use with the printer when operating on Windows 2000.

3.1.1 Bundled Software

The following items included on the enclosed CD-ROM are necessary for usage of the printer on Windows 2000.

- **Microsoft PScript 5 Driver and PPD files**
Microsoft PScript 5 Driver and PPD files (for Windows 2000)
- **Acrobat Reader**
Enables you to view and print PDF files on all major computing platforms.
- **Readme.txt**
Contains the cautionary notes on using the printer driver. Be sure to read this.

3.1.2 Hardware/Software Requirements

The operating environment for the Windows 2000 printer driver is as follows:

Computer System

- i486 or Pentium processor-based personal computer (i486 or Pentium processor recommended)
- 16 MBytes of available RAM (32 MBytes recommended)
- 6 MBytes of available hard-disk space

Basic Software

- Windows 2000 Professional
- Windows 2000 Server
- Windows 2000 Advanced Server



Installing the Printer Driver (Microsoft PScript 5)

The Microsoft printer driver can be installed by simply following the instructions displayed on the dialog boxes. Get ready the enclosed CD-ROM and follow the procedure below.

- Note**  • Click the *Help* button for details on the settings and the method of operation.
- Click the *Cancel* button in the dialog box to end the installation and the *Back* button to cancel the setting at that stage and return to the previous dialog box.

3.2.1 Method of Installation

Procedure

- 1 Start Windows 2000 and click **My Computer**> **Control Panel**>**Printers**. Then double-click the “Add Printer” icon. The “Add Printer Wizard” dialog box is displayed.
- 2 Click **Next**.



3.2 Installing the Printer Driver (Microsoft PScript 5)

- 3 If the printer is directly attached to your computer, click **Local printer**. Otherwise, click **Network printer**.

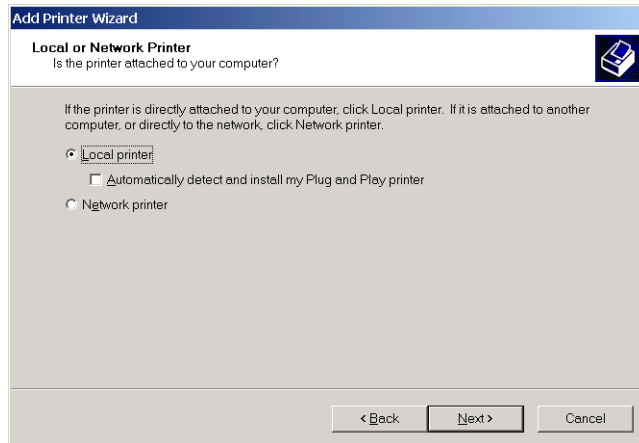

- 4 Select the port to be used and click **Next**.

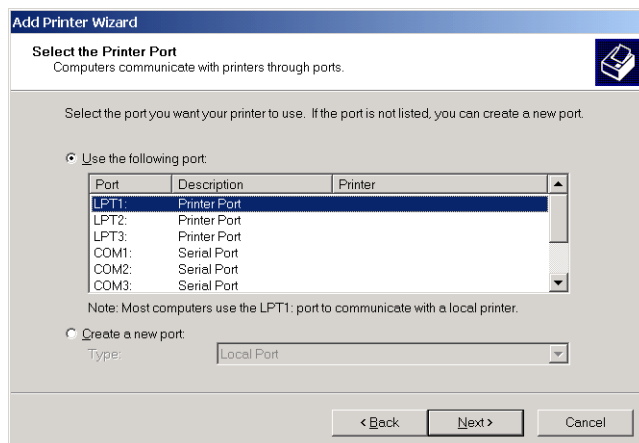

- 5 Click **Have Disk**.

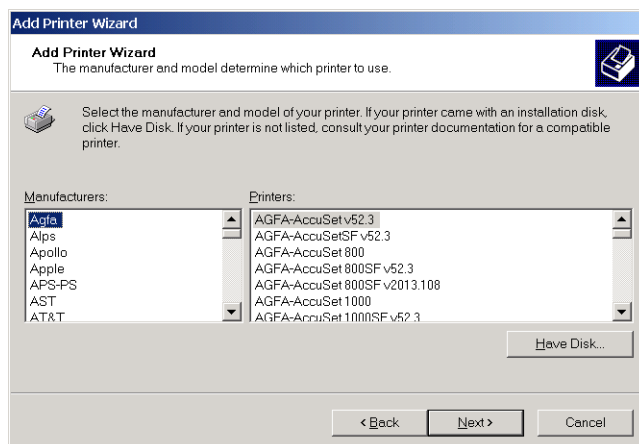

The “Install From Disk” dialog box is displayed.

- 6 Insert the CD-ROM, enter “F:\Driver_PS3\Win2000” and click **OK**.

Note *In this manual, “F:” is used as a CD-ROM drive, but if you are using a different drive for the CD-ROM, please specify accordingly.*

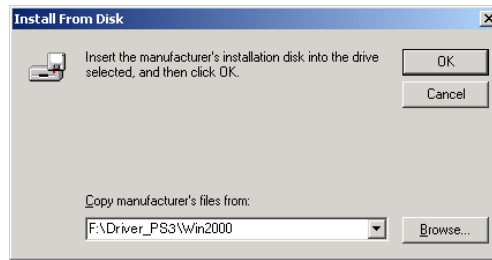

- 7 From the printers available, select **Panasonic DP-6000/7000 PS**. Click **Next**.

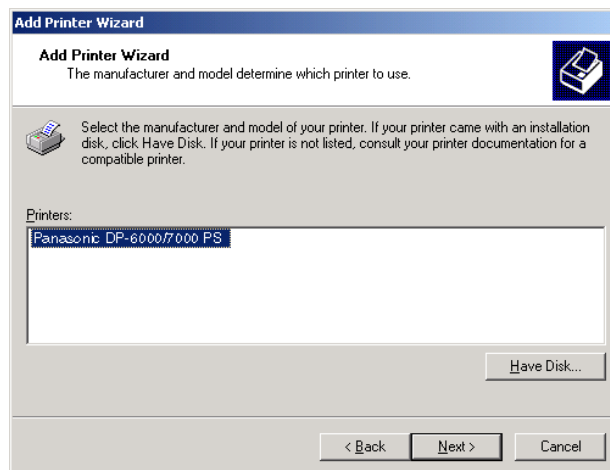

3.2 Installing the Printer Driver (Microsoft PScript 5)

- 8 Input the printer name. Choose whether you want to use the printer as the default printer, then click **Next**. If you do not enter a printer name, the displayed name is used. Click **Yes** if you want to use the printer as a default.

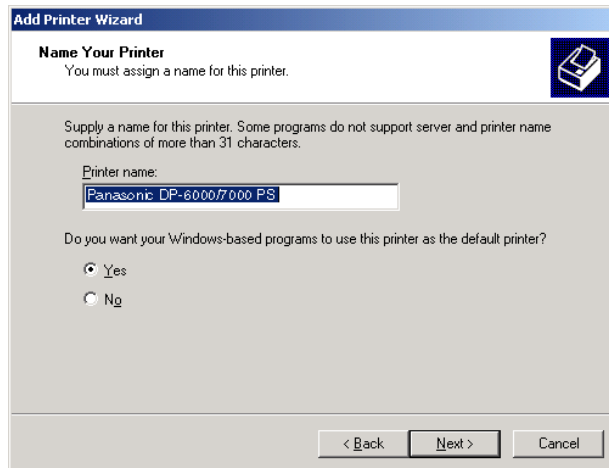

- 9 Choose whether you want to share this printer with the other network users. If you choose **Share as**, input a name for the printer in the text box. Otherwise click **Do not share this printer**. Click **Next**.

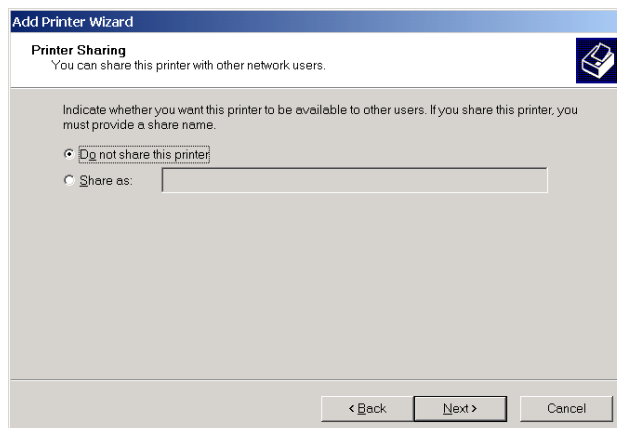

- 10 Choose whether you want to print a test page by clicking **Yes** or **No**. Click **Next**.

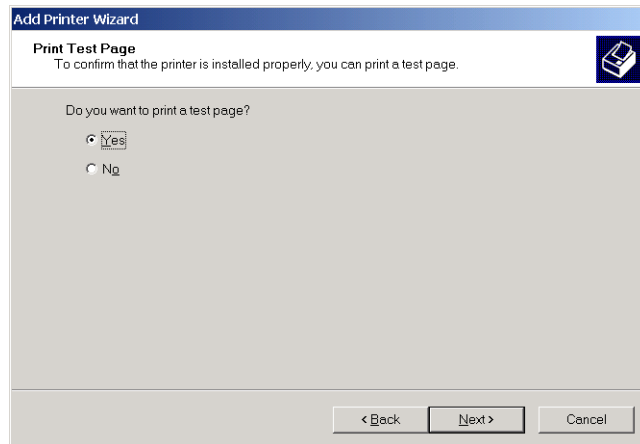

- 11 Click **Finish**.

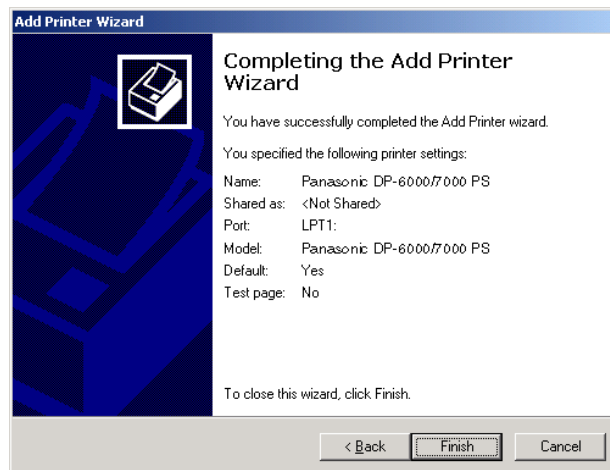

Copying of the files begins and this completes the installation of the printer driver. Take out the CD-ROM. If you have selected to test print, a dialog box is displayed. Click **Yes** if the test print is printed correctly. If it is not, click **No** and follow the instructions on the dialog box.

- Note**
- It is necessary to change the settings on the “Device Settings” tab in order to use the printer’s optional features. Refer to the next section and make sure you change the settings.
 - Store the CD-ROM properly.

3.2.2 Optional Settings

To configure optional settings installed on the printer, select the “Device Settings” tab on the “Printer Properties” dialog box. The following shows how to display the “Device Settings” tab.

Procedure

- 1 Click on the printer icon on the “Printers” window.
- 2 From the “File” menu, click **Properties**.
- 3 Click the “Device Settings” tab.

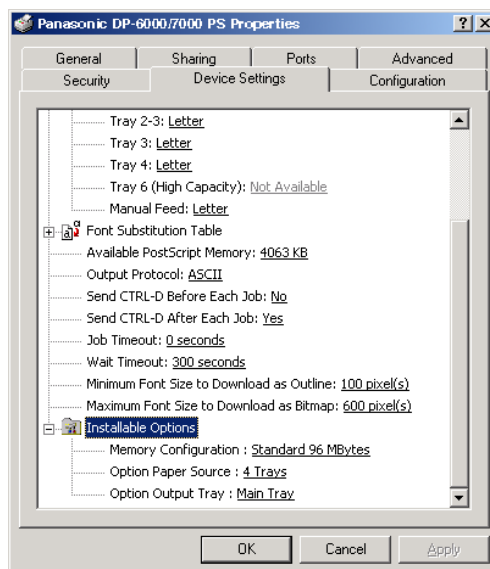

●●● Install able Options

Memory Configuration

The standard memory for this machine is 96 MBytes and this setting cannot be changed.

Option Paper Source

Specify the type of option sheet feeder installed on your printer.

Option Output Tray

Specify the type of option output tray installed on your printer.

3.2.3 Printer Features

You can change settings for the printer features and then print.

Procedure

- ❶ Click on the printer icon on the “Printers” window.
- ❷ From the “File” menu, click **Printing Preferences**.
- ❸ On the “Layout” tab, click **Advanced**.

Note

On the “Layout” tab, you can display and change the layout of the document. For example, when Portrait is selected as the printing orientation, the document can be changed and printed in Landscape orientation.

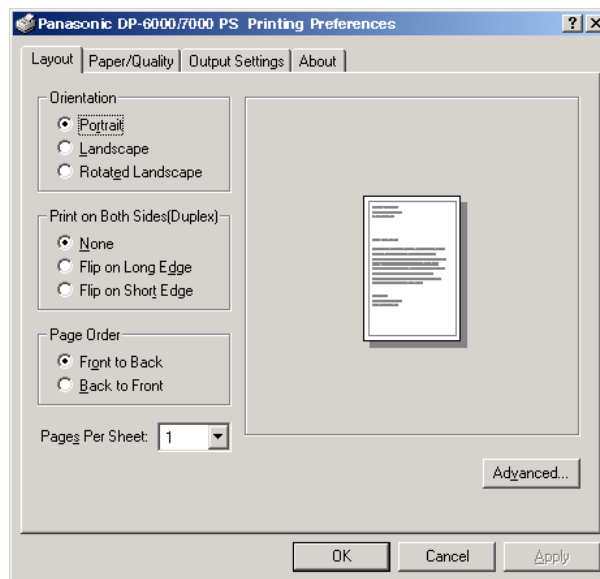

3.2 Installing the Printer Driver (Microsoft PScript 5)

Printer Features

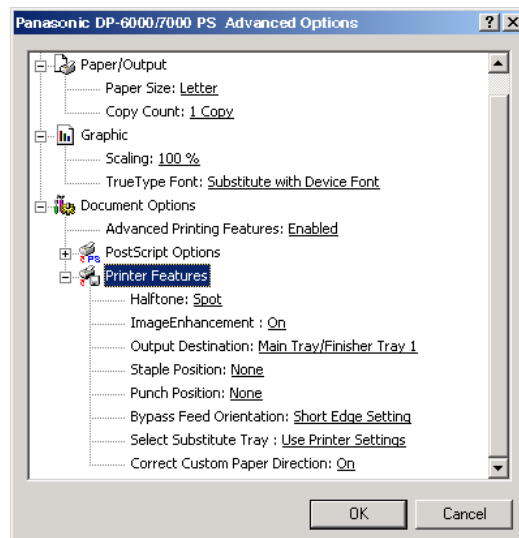

Halftone

Select here the type of toning pattern you want. The settings that are selectable in the application may become invalid.

Image Enhancement

Reduce the slipping and jaggging of the black and white boundary and increase the pseudo resolution.

Output Destination

Specify the output tray installed on your printer. If the optional Finisher is installed, the options available are **Main Tray/Finisher Tray 1** and **Finisher Tray 2**.

Staple Position

Specify whether you want the documents to be stapled and where you want them stapled.

Punch Position

Specify whether you want the documents to be punched and where you want them punched.

Bypass Feed Orientation

Specify **Short Edge Setting** or **Long Edge Setting**.

Select Substitute Tray

The following selections are available:

Use Printer Settings

Nearest size (Adjust to Fit)

Nearest size (No Zoom)

Next larger size (Adjust to Fit)

Next larger size (No Zoom)

Abort Job

Correct Custom Paper Direction

When you are using a non-standard paper size, select the paper direction. Depending on the application, printing may be done incorrectly on the non-standard sized paper. Select **On** to avoid this.





Using Help

Follow the procedure below to use Help and to define the settings.

Procedure

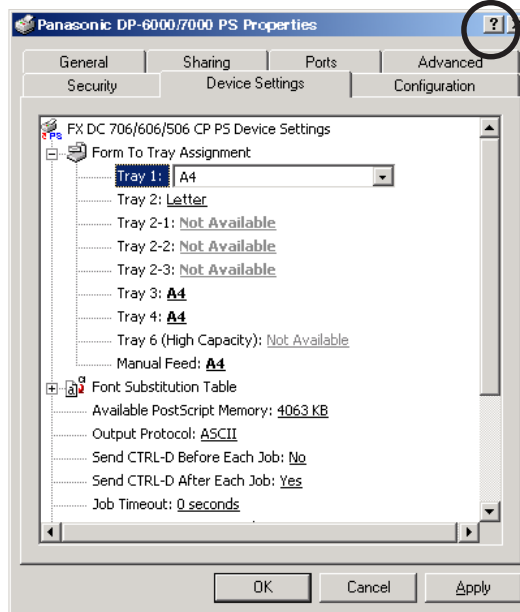
- 1 The  button is located at the top right corner of the dialog box.



- 2 Click . A “?” mark appears next to the mouse pointer. Move the mouse pointer with the “?” mark to the item which you wish to know more about and click on it. This will display a pop-up message with information about that item.

The pop-up message disappears when you click again anywhere on the screen.



4

Installing the Printer Driver for Macintosh

4.1	Configuring the Printer	38
4.2	About the Software	41
4.3	Installing the Printer Driver (AdobePS 8.5/8.7)	42
4.4	Printer Features	47
4.5	Installing the Adobe Screen Fonts	49



Configuring the Printer

When using AppleTalk protocol to print from Macintosh, select **Enable** for EtherTalk port from the touch panel display.

- Using EtherTalk: The printer is connected to the network.

4.1.1 Enabling Port and Setting Protocol

Here, we use enabling EtherTalk on the touch panel display as an example.

Procedure

- 1 Press **Settings/Meter Check**.

**Settings/
Meter Check**



- 2 Select **Tools Mode**.

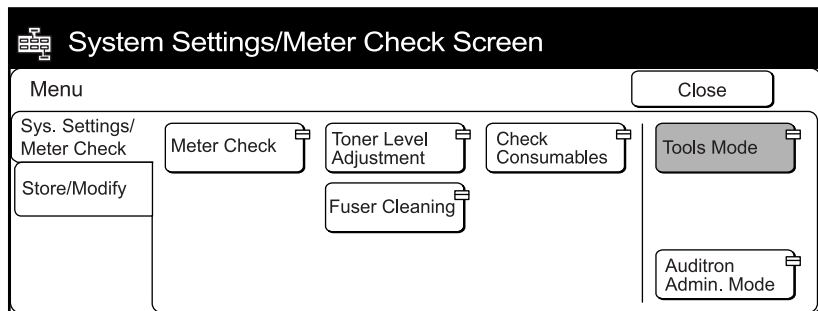

- 3 Enter the access number and select **Confirm**. The default password is set as "11111".

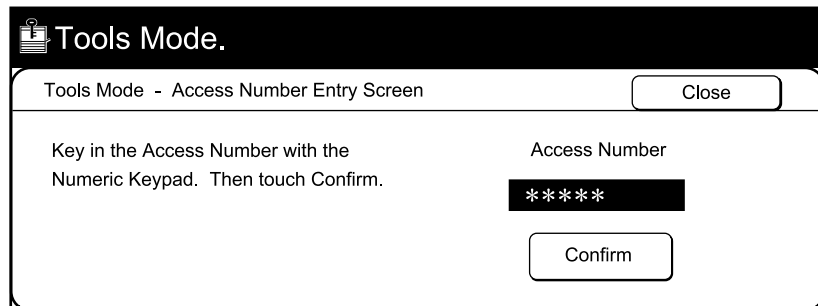

- 4 Select **Print/Scan Mode Settings**.

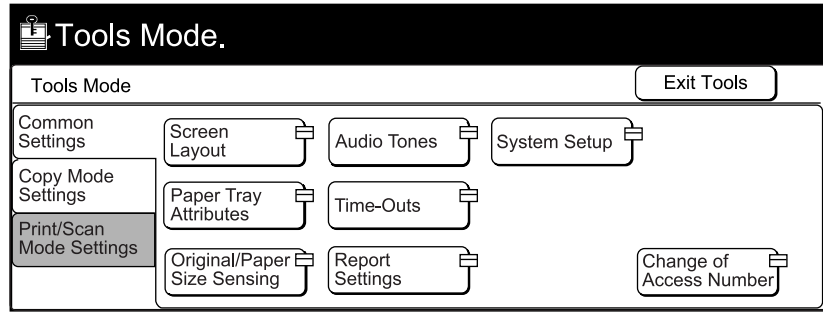

- 5 Select **Port Settings**.

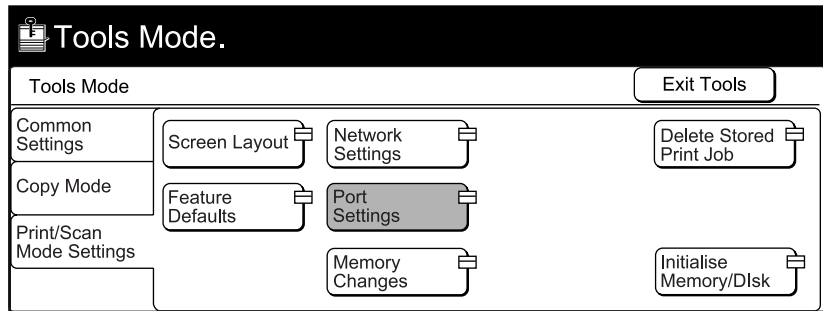

- 6 Select **EtherTalk**.

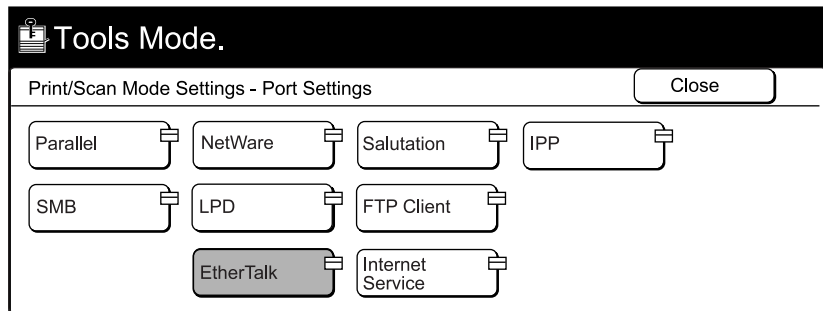

- 7 Select **Port Status** and then select **Change Settings**.

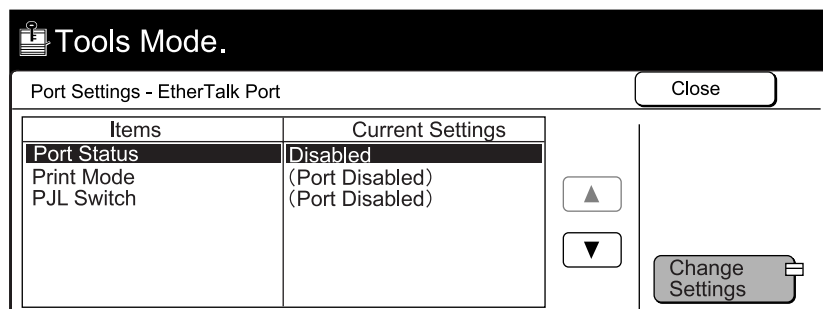

4.1 Configuring the Printer

- ⑧ Select **Enable**.

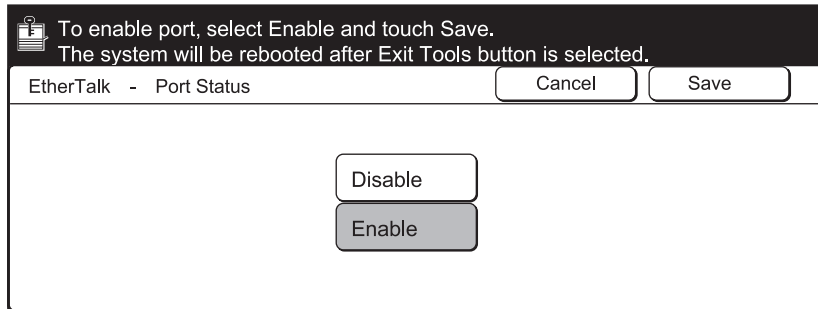

4.1.2 Other Settings

Set the following settings when necessary.

- Print Mode (Default: PostScript)
- PJI Switch (Default: On)
- Apple Talk Receive Buffer (Default: 64 KB)

See... “Chapter 13 Configuring the Tools Mode Screen” in *Operating Instructions (for Printer)* for these items.



About the Software

This section explains the types of software provided and the hardware/software required to use with the printer when operating on Macintosh™.



The “Readme.txt” file contains important notes on using the printer driver and you are recommended to read it.

4.2.1 Bundled Software

Insert the CD-ROM and double-click the CD icon to display the window. The following items are included in the folder:

- **AdobePS printer driver (ver. 8.5.1, 8.7 and 8.7.1) and PPD files**
Adobe PostScript driver and PPD files (for Macintosh).
- **Adobe Screen Fonts**
Contains 117 PostScript fonts and 19 TrueType fonts which are standard for PostScript 3 printers. In addition, 37 PostScript fonts of the Central European (CE) character set are included.
- **ATM (Adobe Type Manager)**
Helps you to install typefaces, activate and manage your fonts. Two versions of the ATM, version 4.0.2 and 4.5.2, are included for Macintosh. Use version 4.5.2 if your operating system is 9.0.
- **Acrobat Reader**
Enables you to view and print PDF files on all major computing platforms.
- **Readme.txt**
Contains the cautionary notes on using the printer driver. Be sure to read this.

4.2.2 Hardware/Software Requirements

The following is the operating environment essential for the printer driver and utility.

Computer System

- For Adobe PS 8.5.1:
Mac OS software version 7.1 or later
- For Adobe PS 8.7:
An Apple Power Macintosh computer running System 8.1 or later
- For Adobe PS 8.7.1:
Mac OS software version 8.6 through 9.1
- 4 MBytes or more of available RAM (32 MBytes recommended)
- 2.1 MBytes of available hard-disk space (4 MBytes recommended)



Installing the Printer Driver (AdobePS 8.5/8.7)

This section explains how to install and configure the printer driver. Get ready the enclosed CD-ROM and follow the procedure below. Here we will install the Adobe PS 8.7.1 as an example.

4.3.1 Installing the Printer Driver

There are two steps to install the printer driver. Firstly, use the installer enclosed in the CD-ROM to install the printer driver to your Macintosh. Then configure the printer driver according to the printer used.

LOOK  Refer also to the "Readme.txt" file.

Follow the installation procedure below to install the Adobe PS Printer Driver.

Procedure

- 1 Insert the CD-ROM into the CD-ROM drive. Double-click the CD-ROM icon on the desktop to display its window.
- 2 In the "CD-ROM" window, double-click the "Driver PS3" folder and then the "AdobePS 871" folder. Double-click the AdobePS Installer. The following window appears.



- 3 Click **Continue**.
The "license agreement" dialog box appears.

- 4 Read through the agreement carefully and if you have no objections to it, click **Accept** and **Continue**.



The “AdobePS Installer 8.7.1” window appears.

- 5 Click **Install**.

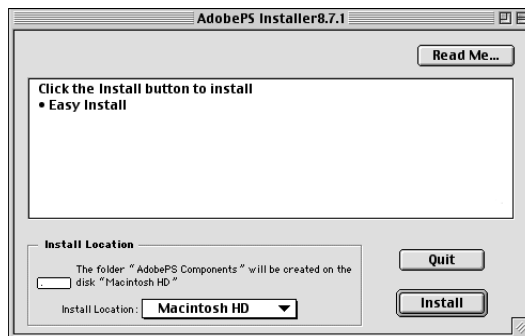

The installation process begins.

Note  A warning message will appear if you did not quit all other applications before performing the installation.

- 6 After the installation is completed, the following message appears. Click **Quit** to quit the program, **Continue** if you wish to perform additional installations such as the bundled screen fonts, or **Restart** to restart Macintosh. To ensure proper operation, it is recommended that you restart the computer.

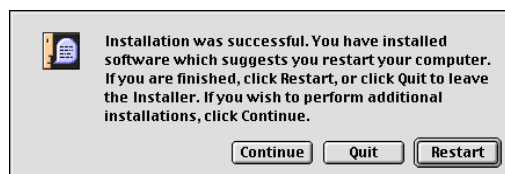

Next, proceed to configure the printer driver.

4.3.2 Configuring the Printer Driver

After the installation is completed, you have to set up your printer driver by selecting the relevant PostScript Printer Description (PPD) files, and configure the driver by specifying the options installed on your printer. Certain features related to the options will only be available if you have indicated that they are installed.

Procedure

- 1 Click and hold down the mouse on the “Apple” icon on the top left hand corner of the desktop. A drop-down menu appears. Select **Chooser**. The “Chooser” window appears.

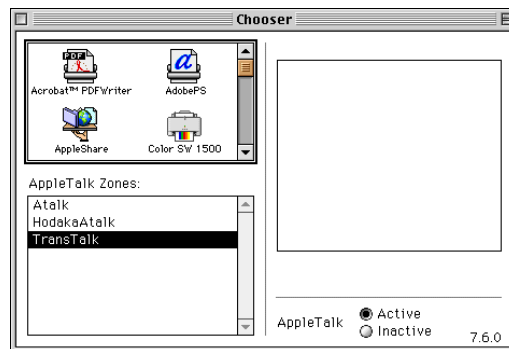

- 2 Select or double-click the AdobePS icon in the left scroll box and then select **Panasonic DP-6000/7000 PS** on the right. Click **Create**.
By clicking **Create**, the relevant PPD file will be selected and the driver will be configured automatically. The “Chooser” window reappears after the configuration is completed.

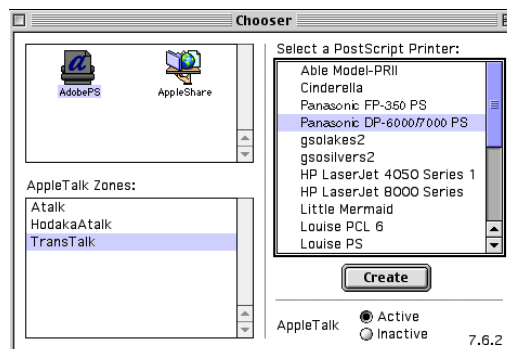

If the automatic configuration of the printer driver cannot be completed under a certain condition, a screen prompting you to select a PPD file will appear. Follow the instructions. Then proceed to ③.

- 3 Select **Panasonic DP-6000/7000 PS** from the “Printer Descriptions” list box, and click **Select**.

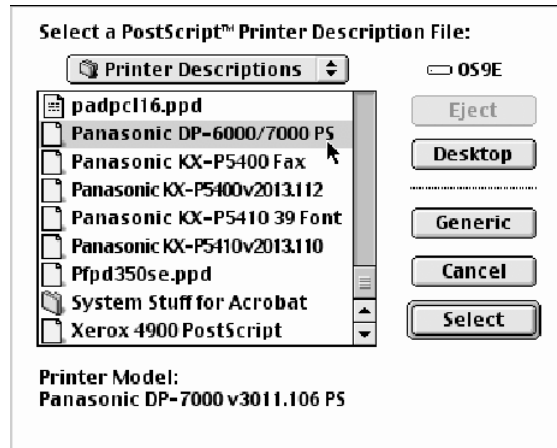

- 4 When the printer is set up, a printer icon will be displayed next to **Panasonic DP-6000/7000 PS** in the “Chooser” window.

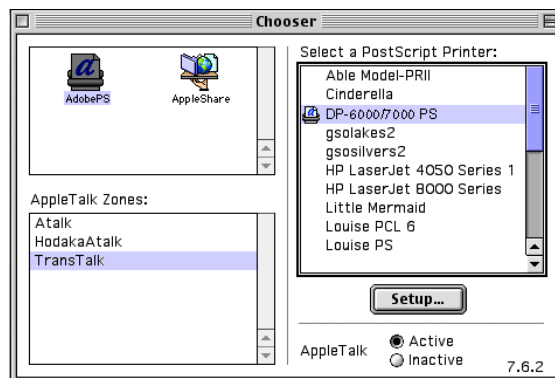

If the installed options are not set in the printer driver correctly, click **Setup** and proceed to the next step.

If none of them are installed on your printer, you may now send print jobs to the printer.

4.3 Installing the Printer Driver (AdobePS 8.5/8.7)

- 5 Click **Configure**.

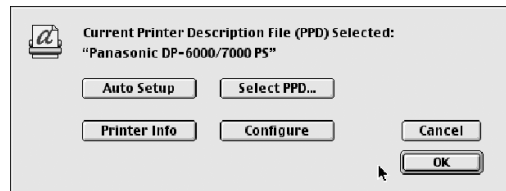

The window listing the various printer options appears.

Note *If you install Adobe PS 8.5, Help button will be displayed on this screen. Click **Help** and the explanation for the respective items will be displayed. Once you have finished reading, click **Done** to exit.*

- 6 Specify options installed on your printer. Then click **OK**.

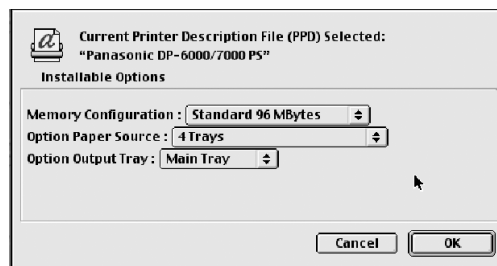

Memory Configuration

The standard memory for this machine is 96 MBytes and this setting cannot be changed.

Option Paper Source

If the HCF is installed on your printer, select **4 Trays (HCF)**.

Option Output Tray

Select the option output tray installed on the printer.

- 7 Click **OK** again to return to the “Chooser” window.
The setting up of the printer is completed.



Printer Features

You can set the printer specific options when printing.

4.4.1 Printer Specific Options

The following procedures show how to set the options.

Procedure

- 1 Open the application and select **Print** from the “File” menu.
- 2 Select **Printer Specific Options**.

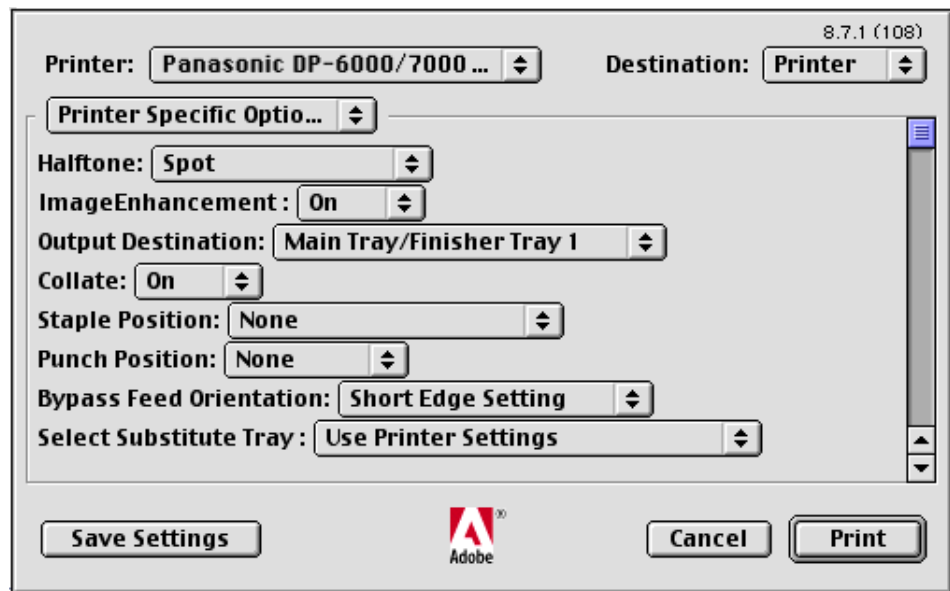

Printer Specific Options

Specify the printer options. The items that can be selected vary according to the printer model and optional settings.

Halftone

Select here the type of toning pattern you want. The settings that are selectable in the application may become invalid.

Image Enhancement

Reduce the slipping and jaggging of the black and white boundary and increase the pseudo resolution.

Output Destination

Specify the output tray. The output trays change according to the optional settings.

Collate

Specify whether you want the documents to be collated or not.

Staple Position

Specify whether you want the documents to be stapled and where you want them stapled.

Punch Position

Specify whether you want the documents to be punched and where you want them punched.

Bypass Feed Orientation

Specify **Short Edge Setting** or **Long Edge Setting**.

Select Substitute Tray

The following selections are available:

Use Printer Settings

Nearest size (Adjust to Fit)

Nearest size (No Zoom)

Next larger size (Adjust to Fit)

Next larger size (No Zoom)

Abort Job

Correct Custom Paper Direction

When you are using a non-standard paper size, select the paper direction. Depending on the application, printing may be done incorrectly on the non-standard sized paper. Select **On** to avoid this.

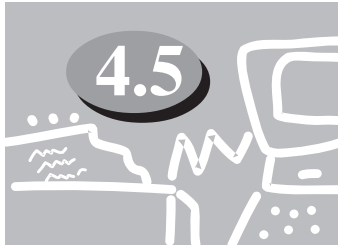

Installing the Adobe Screen Fonts

This section explains how to install the fonts in the Screen Font folder.

It is recommended to close all other applications before installing the fonts. Otherwise, a warning message will appear between steps ⑤ and ⑥.

Procedure

- ① Start Macintosh and insert the CD-ROM into the CD-ROM drive.
- ② Double-click on the “CD-ROM” icon followed by the “Screen Font” folder and then the “PS3FontsInstaller” icon. The following window appears:



- ③ Click **Continue**.
The “license agreement” dialog appears.
- ④ Read through the agreement carefully and if you have no objections to it, click **Accept**.

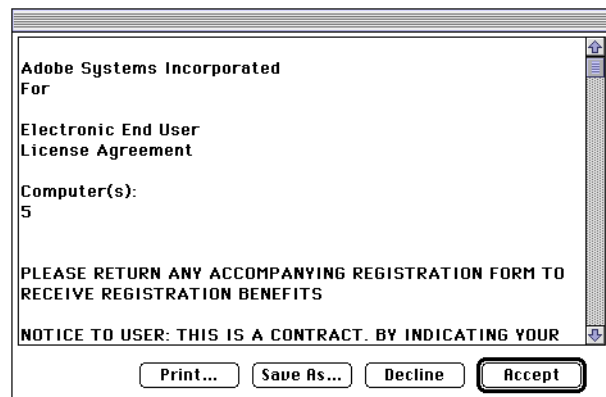

The “PS3FontsInstaller” dialog appears.

4.5 Installing the Adobe Screen Fonts

- 5 You may select **Easy Install** or **Custom Install**.
Easy Install installs all the fonts provided in the “Screen Font” folder.

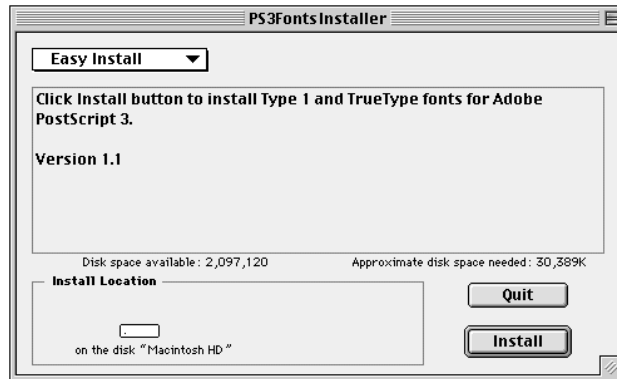

Custom Install installs the selected fonts only. Simply click on the triangle arrow beside the four categories of fonts to display the fonts in each category and then check the fonts to be installed. For example, the diagram below shows that **Arial CE** of the “CE TrueType” fonts is selected.

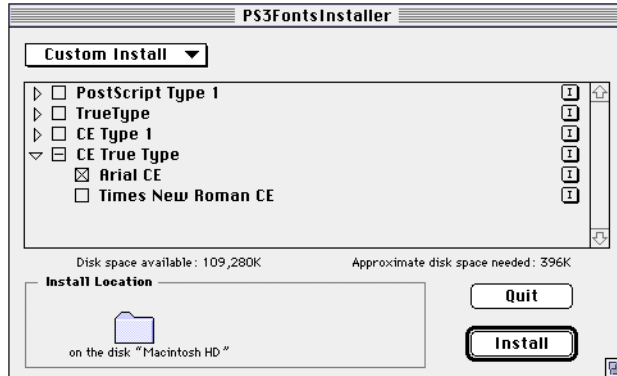

Note  A warning message will appear if you did not quit all other applications before performing the font installation.

- 6 Click **Install**.
The installation of the fonts begins.
After the installation, you have to restart your Macintosh before the fonts can be used.



Appendix

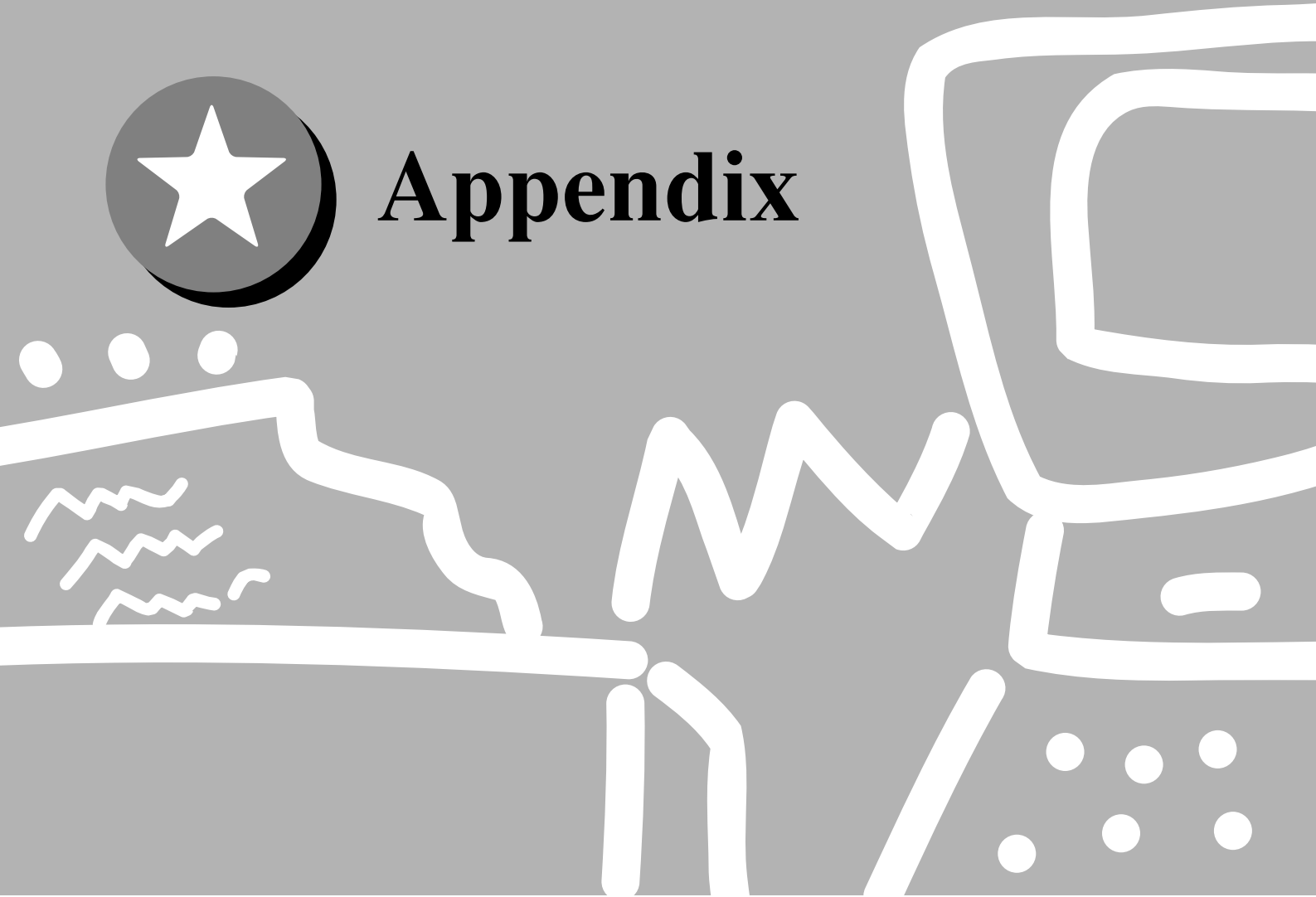

A	Cautions/Limitations	52
---	----------------------------	----

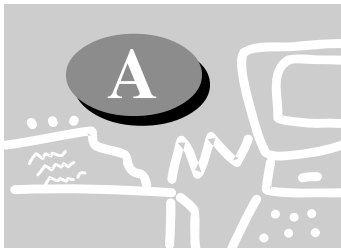

Cautions/Limitations

Take note of the following when operating the machine.

●●● Drivers

The cautionary notes of each of the drivers are listed in “Readme.txt” or “Read Me First”. Be sure to read these before installation.

●●● Stapling and Hole-punching

To staple or hole-punch, set Collate to **ON** and select **Finisher Tray 2** for the output destination.

The list below shows the types of paper on which the printer can perform the stapling function. Also listed below are the stapling options for you to choose.

LOOK  “□” indicates that the paper in the tray is loaded in the portrait orientation. It does not refer to the orientation specified on the “Paper” tab dialog box.

- A3, A4, B4, B5, 8.5x11”, 8.5x13”, 8.5x14”, 11x17” and 8K:
 - Top Left Corner
 - Bottom Left Corner
 - Top Right Corner
 - Bottom Right Corner
 - Top Double
 - Bottom Double
- A4 □ , A5 □ , B5 □ , 8.5x11” □ :
 - Top Left Corner
 - Bottom Left Corner
 - Top Right Corner
 - Bottom Right Corner
 - Left Double
 - Right Double

The following are the types of paper used for hole-punching and the possible options on where to staple.

- A3, B4, 11x17” :
 - Top
 - Bottom
- A4 □ , B5 □ , 8.5x11” □ :
 - Left
 - Right

- Note**  • The hole-punch/staple position differs according to the orientation of the paper for paper sizes A4, A5, B5 and 8.5x11”. When you want to make use of the hole-punching/stapling feature, make sure that the paper is loaded correctly in the tray.
- If you have indicated an impossible hole-punch/staple position, the printer may not print properly.

●●● **Hole-Punching/Stapling Feature for Mixed Size Originals**

The stapling/punching function is not available for printing mixed size originals using the PostScript driver.

●●● **Limitations**

When the following conditions are indicated, the actual output destination can only be Finisher Tray 1.

- **Collate** is set to **OFF** and **Finisher Tray 2** is selected for the output destination.



Index

A

About the Software	
For Macintosh	41
For Windows 2000	26
For Windows 95/98/Me	2
For WindowsNT4.0	14
Acrobat Reader	2, 14, 26, 41
Adobe Screen Fonts	2, 14, 41
For Macintosh	iii
For Windows	ii
Installing	49
Adobe Type Manager	ii, iii, 2, 14, 41
AdobePS 4.4 (Windows 95/98/Me)	3
Installing	3
AdobePS 5.1 (WindowsNT 4.0)	15
Installing	15
AdobePS 8.5/8.7 (Macintosh)	iii, 42
Configuring	44
Installing	42
AdobePS Installer	42

B

Bundled Software	
For Macintosh	41
For Windows 2000	26
For Windows 95/98/Me	2
For WindowsNT 4.0	14

C

Cautions/Limitations	52
Configuring the Printer Driver	
In Macintosh	44

E

EtherTalk	38
-----------------	----

H

Hardware/Software Requirements	
For Macintosh	41
For Windows 2000	26
For Windows 95/98/Me	2
For WindowsNT4.0	14
Help	11, 23, 36

I

Installing the Printer Driver	
In Macintosh	42
In Windows 2000	27
In Windows 95/98/Me	3
In WindowsNT4.0	15

P

PostScript Driver Library	ii
PostScript Fonts	2, 14, 41
PPD files	2, 14, 26
Printer Driver	iii
Printer Features	34

T

TrueType fonts	2, 14, 41
----------------------	-----------

U.S.A. only

WARRANTY

PANASONIC DOCUMENT IMAGING COMPANY MAKES NO WARRANTIES, GUARANTEES OR REPRESENTATIONS, EXPRESSED OR IMPLIED, TO CUSTOMER WITH RESPECT TO THIS PANASONIC MACHINE, INCLUDING BUT NOT LIMITED TO, ANY IMPLIED WARRANTY OF MERCHANTABILITY OR FITNESS FOR A PARTICULAR PURPOSE.

PANASONIC DOCUMENT IMAGING COMPANY ASSUMES NO RISK AND SHALL NOT BE SUBJECT TO LIABILITY FOR ANY DAMAGE, INCLUDING, BUT NOT LIMITED TO DIRECT, INDIRECT, SPECIAL, INCIDENTAL OR CONSEQUENTIAL DAMAGES OR LOSS OF PROFITS SUSTAINED BY THE CUSTOMER IN CONNECTION WITH THE USE OR APPLICATION OF THIS PANASONIC MACHINE. SEE YOUR DEALER FOR DETAILS OF DEALER'S WARRANTY.

For Service Call: _____

Panasonic Document Imaging Company
A Business Unit of Matsushita Electric Corporation of America
Two Panasonic Way
Secaucus, New Jersey 07094

Panasonic Canada Inc.
5770 Ambler Drive
Mississauga, Ontario L4W 2T3

DZRQ000051 S1001
October 2001
Printed in Japan